

**Features**

- ▶ Typical wavelength, 655nm
- ▶ Stabilized optical power
- ▶ Attached deflection lens
- ▶ Adjustable beam according to distance
- ▶ Single supply voltage, 5V DC
- ▶ Low power consumption
- ▶ Wire length : 30cm(standard) or custom
- ▶ Built-in waterproof equipment
- ▶ A use of near distance
- ▶ Laser class : 1 (IEC 60825-1:2007)

**Specification**

● **Optical (@RT)**

Items	Values	Unit
Optical output power	<1	mW
Peak wavelength	655±5	nm
Collimated beam wid. (@FWHM)	<1.5 (@2M)	mm
Fan angle	45	°
Line pattern	Accurate cross	
Beam intensity pattern	Gaussian	

● **Electrical (@RT)**

Items	Values	Unit
Operating voltage	5±5%	DC V
Operating current	25 (typ.)	mA
Drive circuit	APC	
Operating temp.	-10 ~ +50	°C
Storage temp.	-40 ~ +85	°C
LD Pin Connection	Case positive	

● **Mechanical**

Items	Values	Unit
Weight	13.5±1	g
Dimensions(mm)	Ø12*42	mm
Housing material	Aluminum	

**Description**

The NCW series laser diode module combines laser diode technology, quality optics and sophisticated electronics within a slim and light aluminum anodized housing for variety of applications. This series of modules provides cross laser beam in variety power and wavelengths. Applications include a measurement, positioning, lighting, alignment, guidelines, pointing, switching, leveling and machine vision etc. Useful in a variety of medical, industrial, and scientific instrumentation as well as general R&D work.

**Drawings**

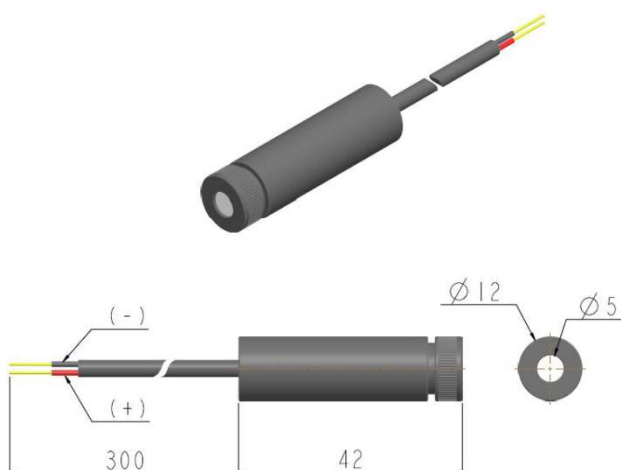

**\* Line length by distance**

Distance (mm)	Cross length (mm)
100	about 80*80
300	about 250*250
500	about 430*430
1000	about 830*830

◆ **Warranty : One-year**

◆ **Accessory : Bracket (Mount) & Power adaptor**

**Lanics Co., Ltd.**  
Room #703, 7F Woolim e-Biz Center  
170-5, Guro-dong, Guro-gu, Seoul, 152-050, Korea  
TEL : +82-2-2108-2255 FAX : +82-2-2108-2260  
E-mail : support@lanics.com  
http:// www.lanics.com