

Features

- ▶ Typical wavelength, 635nm
- ▶ Stabilized optical power
- ▶ Single supply voltage, 5V DC
- ▶ Collimated beam
- ▶ Low power consumption
- ▶ Wire length : 30cm(standard) or custom
- ▶ Laser class : 3R (IEC 60825-1:2007)

Specification

◆ **Optical (@RT)**

Items	Values	Unit
Optical output power	2.5±10%	mW
Peak wavelength	635±5	nm
Focused beam dia. (@FWHM)	<0.2 (@300mm)	mm
Collimated beam dia. (@FWHM)	<3x2(@10M)	mm
Collimated beam div.	<0.5	mrad
Beam quality	TEM00, M ² <1.5	
Beam intensity pattern	Gaussian	

◆ **Electrical (@RT)**

Items	Values	Unit
Operating voltage	5±5%	DC V
Operating current	40 (typ.)	mA
Drive circuit	APC	
Operating temp.	-10 ~ +50	°C
Storage Temp	-40 ~ +80	°C
LD Pin Connection	Case ground Case positive	

◆ **Mechanical**

Items	Values	Unit
Weight	13.5±1	g
Dimensions(mm)	Ø12*45	mm
Housing material	Aluminum	

Description

The NG series laser diode module combines laser diode technology, quality optics and sophisticated electronics within a slim and light aluminum anodized housing for variety of applications. This series of modules provides a elliptical laser beam in a variety of power and wavelength. Applications include a measurement, positioning, lighting, alignment, guidelines, pointing, switching, leveling and machine vision etc. Useful in a variety of medical, industrial, and scientific instrumentation as well as general R&D work.

Drawings

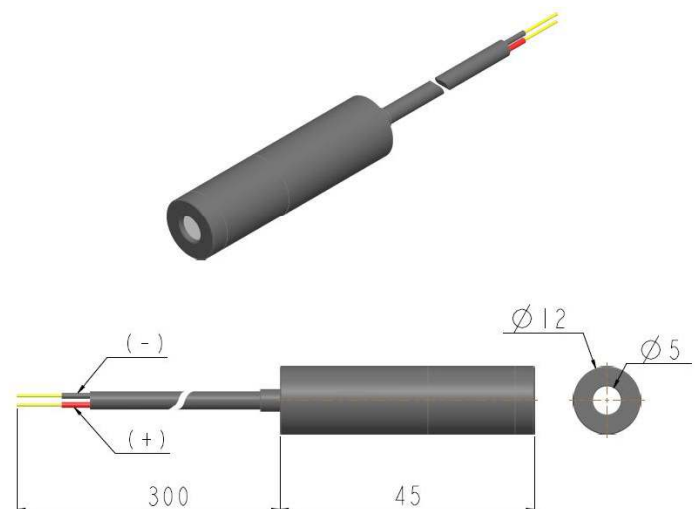

- ◆ **Warranty : One-year**
- ◆ **Accessory : Bracket (Mount) & Power adaptor**

Lanics Co., Ltd.
Room #703, 7F Woolim e-Biz Center
170-5, Guro-dong, Guro-gu, Seoul, 152-050, Korea
TEL : +82-2-2108-2255 FAX : +82-2-2108-2260
E-mail : support@lanics.com
http:// www.lanics.com